

Varitile Classic







Varitile[®]

weather [p]roof

**Make a statement
with strong, bold lines**

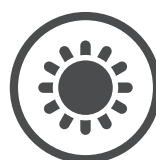
Varitile Classic is a well-defined tile and one of the most popular profiles offered. Sharp, clean lines and sloping edges bring added depth, enhancing your roofline.

www.varitile.com

- 
WIND
- 
HAIL
- 
FREEZE/THAW
- 
ENERGY
- 
LIGHTNING
- 
IMPENETRABLE
- 
EARTHQUAKE
- 
FIRE

Varitile Classic

Formed from the highest quality steel and protective coatings, Varitile is incredibly strong, lightweight and weather resistant.

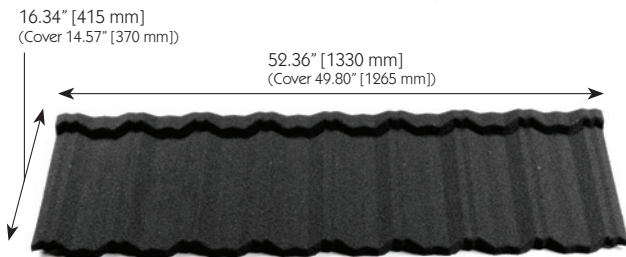

SPECIFICATIONS

Minimum pitch	2/12	[10°]
Maximum pitch	vertical	[90°]
Size of tile - overall*	52.36" x 16.34"	[1330 x 415 mm]
Size of tile - cover*	49.80" x 14.57"	[1265 x 370 mm]
Gauge of steel**	26 gauge ZA300	[0,45 mm ZA300]
Linear cover width*	49.80"	[1265 mm]
Tiles per square	19.83 pc	[2,14 pc/m ²]
Weight per square*	131 pounds	[6,41 kg/m ²]
Weight per tile*	6.61 pounds	[3,00 kg]

* The measurements and the weight may vary slightly by the finish that is added to the panel.
** Steel thickness according to the EN 10346.

STANDARD COLORS



More colors available.
Ask your dealer for information.

INSTALLATION

Classic can be installed left to right or right to left. For maximum visual appeal and performance, stagger at least one pan width.

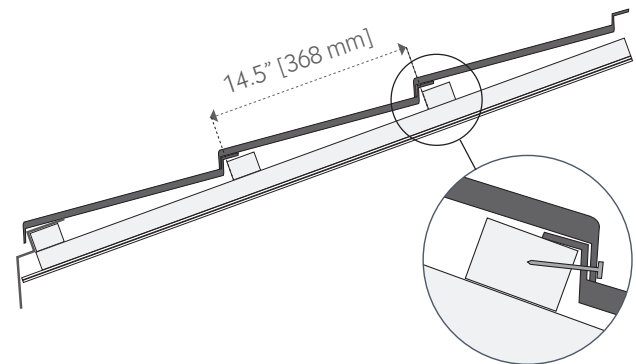

Panels are placed on nominal 2x2 wood battens spaced 14.5" [368mm].

A downturned front edge (nose) and upturned rear edge (shelf) on each tile creates a strong, weatherproof, overlapping and interlocking assembly. Each tile is secured with four nails in the panel nose, away from water channels.

ACCESSORIES

Varitile offers a broad range of accessories.

- **Ridges, junctions and end caps.**
Offered in angled, squared and curved profiles.
- **Fascia, sidewall and headwall transition flashings.**
- **Ventilation systems.**
- **Installation Equipment:** nails, benders, guillotines.
It is important to use tools recommended by Varitile.

For a complete and detailed list of accessories and more information regarding the installation of a Varitile roof, contact your dealer.